

Article number: 391804907042710

Description: Worm gear with st. steel hollow shaft  
VF 49 EP-F2-70- 71B5

## Measures

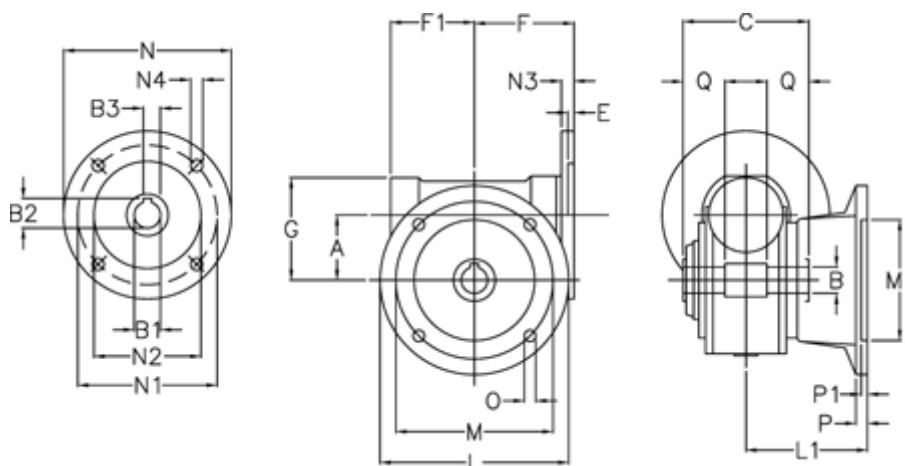

a	= 49.5	F1 = 63	N2 = 110
B	= 25	g = 80	N3 = 10.5
B1 E7	= 14	L = 125	N4 = 9.5
B2	= 16.3	L1 = 85.5	O = 10.5
B3 H9	= 5	m = 90	P = 12
C	= 82	M1 = 70	P1 = 10
E	= 3.0	N = 160	Q = 22.5
F	= 70	N1 = 130	